

Timber-Concrete Composite floor system (TCC)

Konrad Merz

**merz
kley
partner**











- When and Why?
- Composite action
- Classification
- Projects



- When and Why?
- Composite action
- Classification
- Projects

Residential floor system

About 5 m span length

$L'_{nT,W} \approx 43$ dB (Weighted Standardized Impact Sound Pressure Level)

Residential floor system

About 5 m span length

$L'_{nT,W} \approx 43$ dB (Weighted Standardized Impact Sound Pressure Level)

Timber floor

100 kg/m²

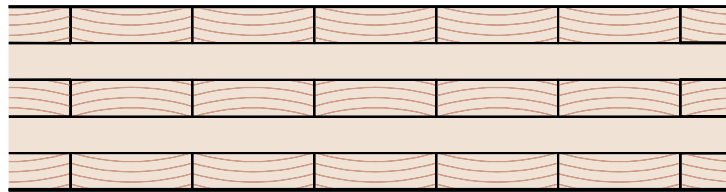

200 mm

Residential floor system

About 5 m span length

$L'_{nT,W} \approx 43$ dB (Weighted Standardized Impact Sound Pressure Level)

Timber floor

150 kg/m²

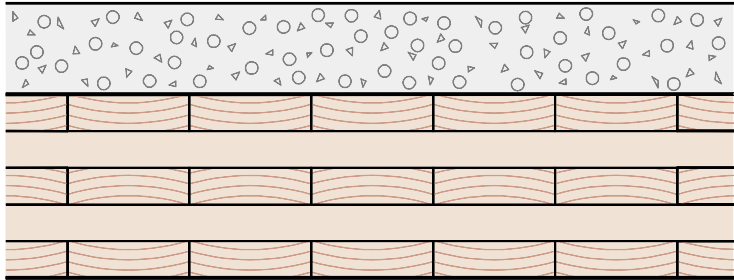

100 mm

100 kg/m²

200 mm

Residential floor system

About 5 m span length

$L'_{nT,W} \approx 43$ dB (Weighted Standardized Impact Sound Pressure Level)

Timber floor

150 kg/m²

100 kg/m²

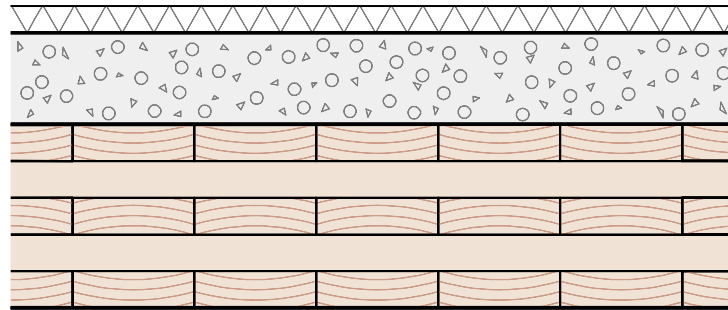

30 mm

100 mm

200 mm

Residential floor system

About 5 m span length

$L'_{nT,W} \approx 43$ dB (Weighted Standardized Impact Sound Pressure Level)

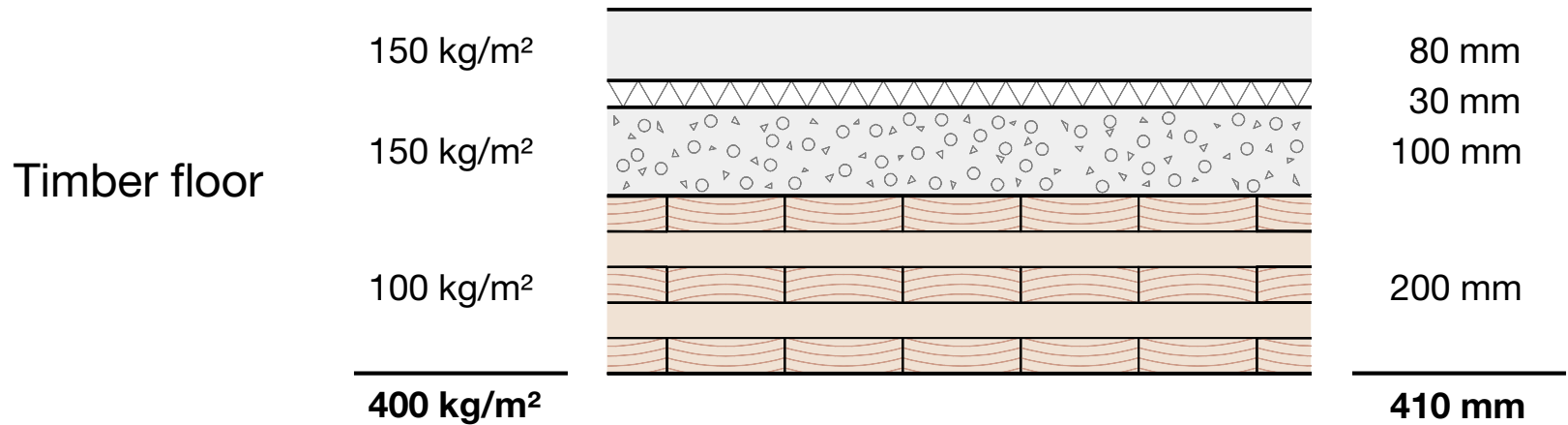

Residential floor system

About 5 m span length

$L'_{nT,W} \approx 43$ dB (Weighted Standardized Impact Sound Pressure Level)

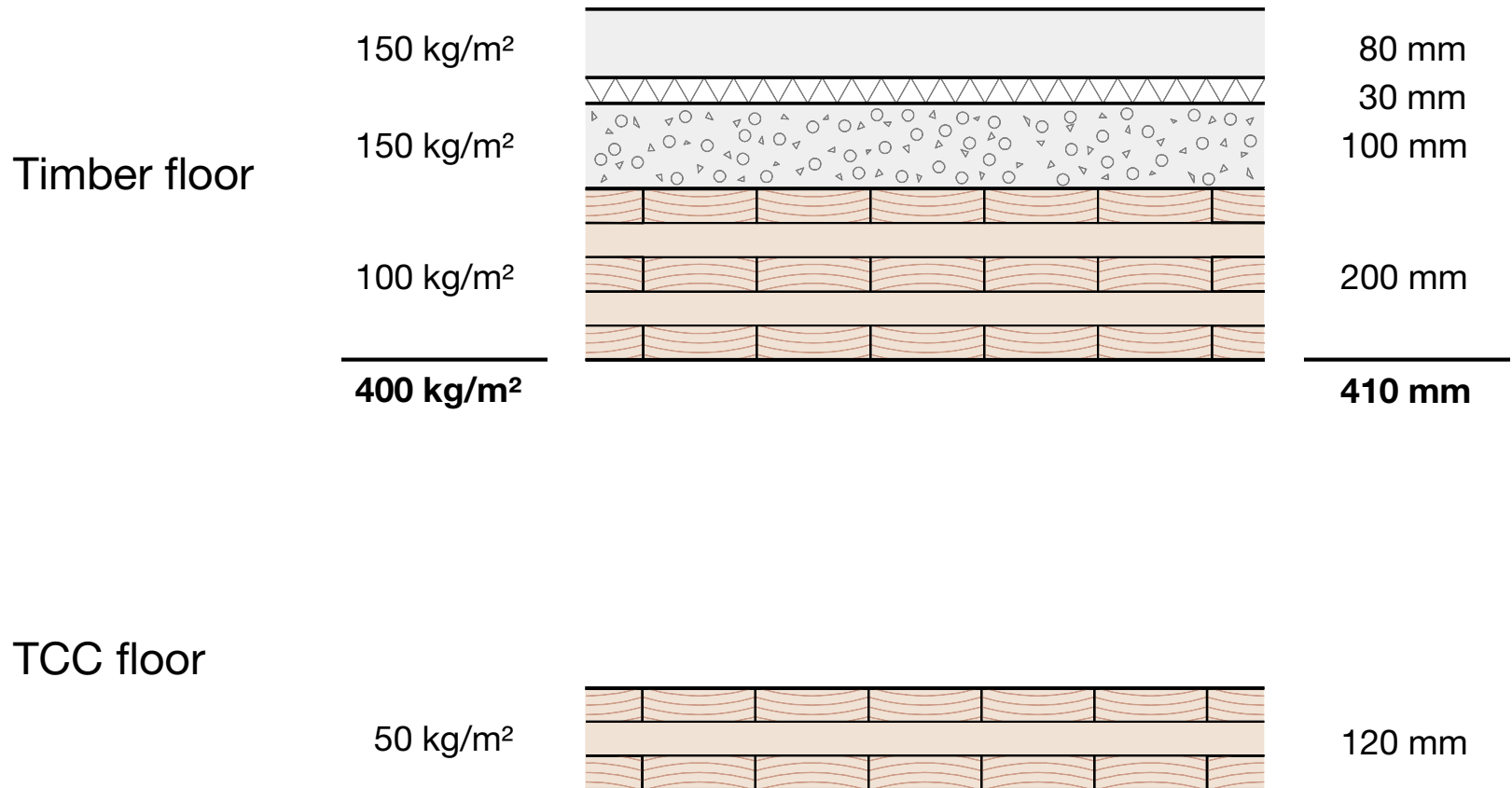

Residential floor system

About 5 m span length

$L'_{nT,W} \approx 43$ dB (Weighted Standardized Impact Sound Pressure Level)

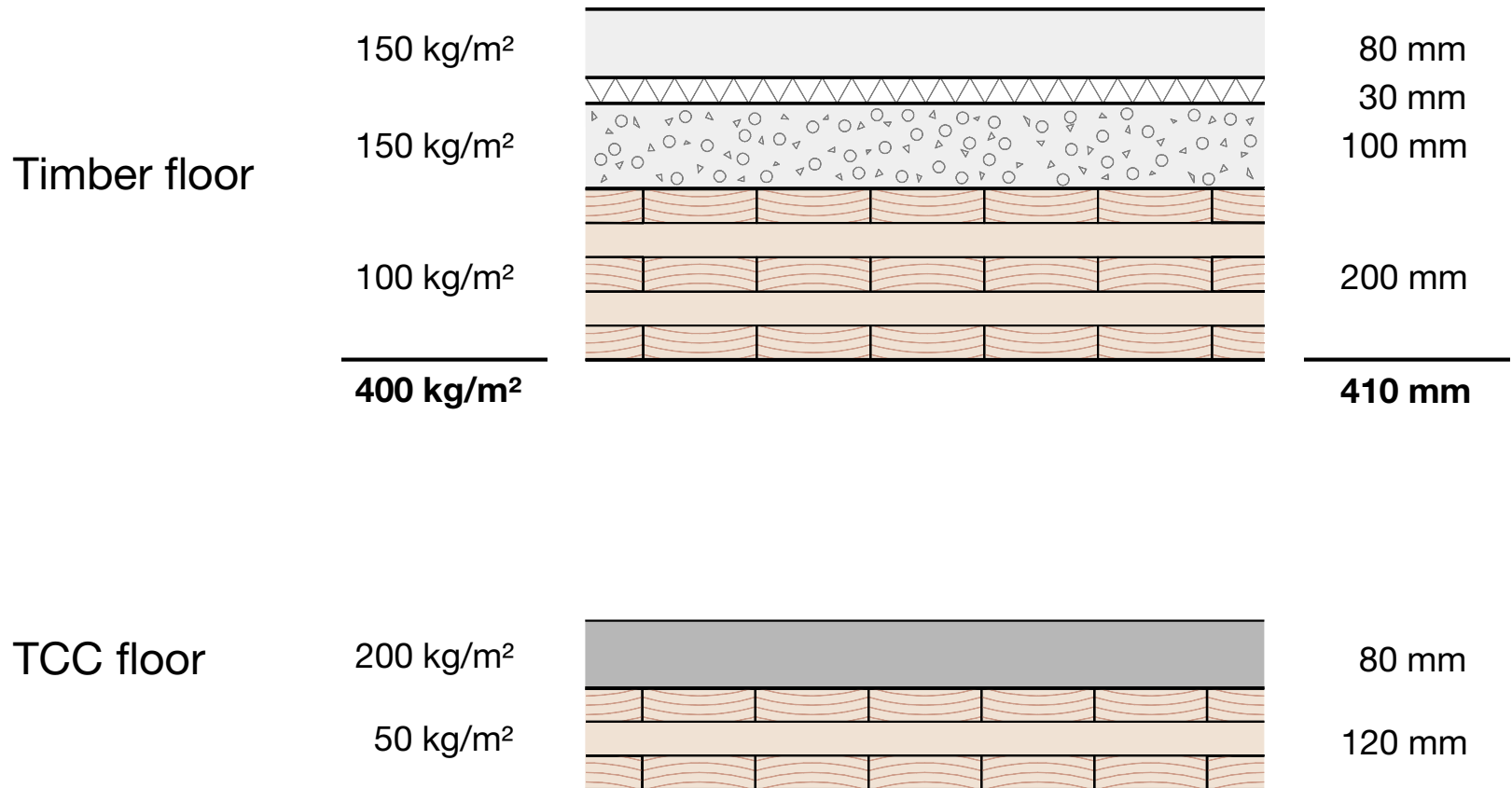

Residential floor system

About 5 m span length

$L'_{nT,W} \approx 43$ dB (Weighted Standardized Impact Sound Pressure Level)

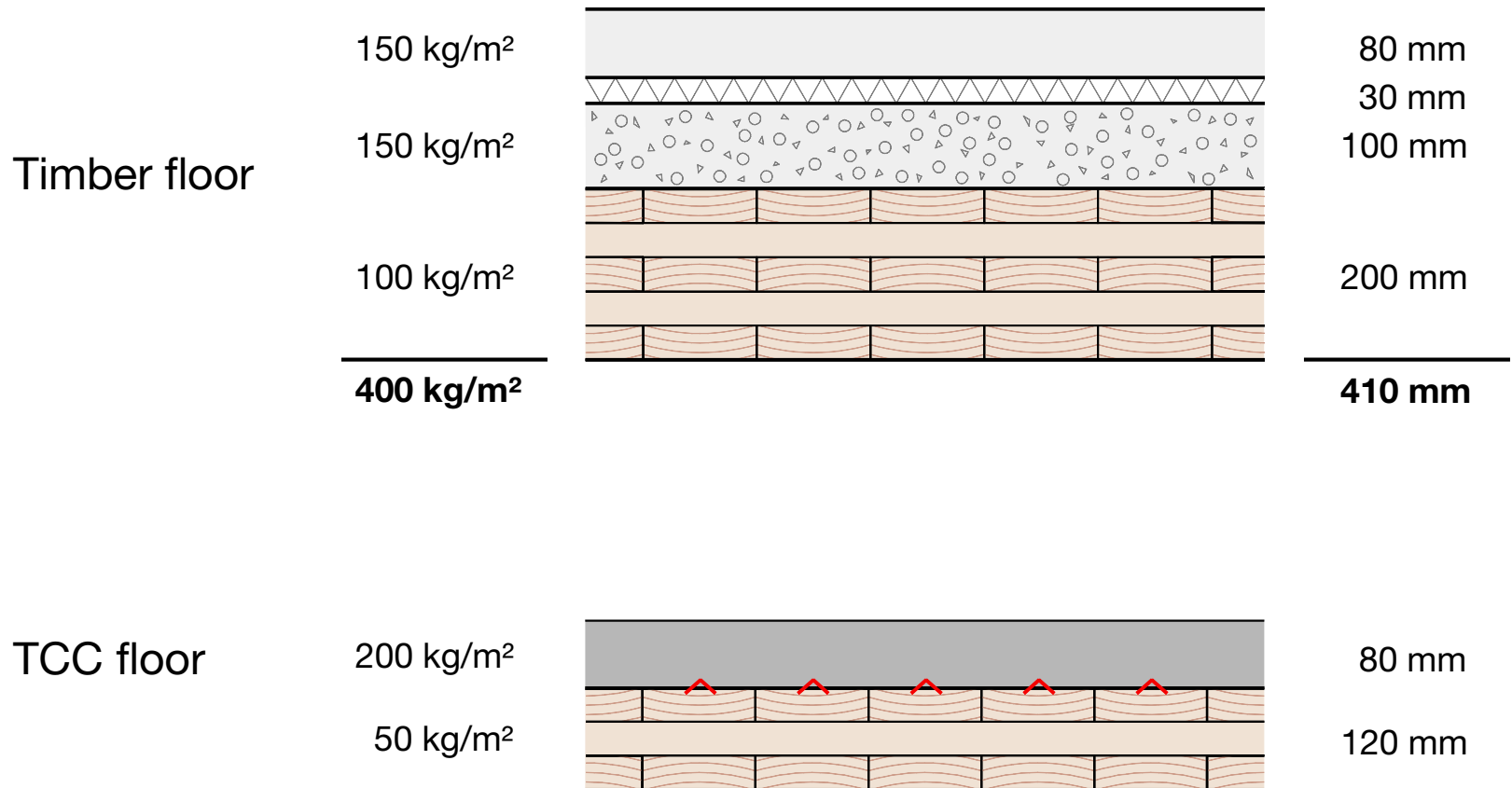

Residential floor system

About 5 m span length

$L'_{nT,W} \approx 43$ dB (Weighted Standardized Impact Sound Pressure Level)

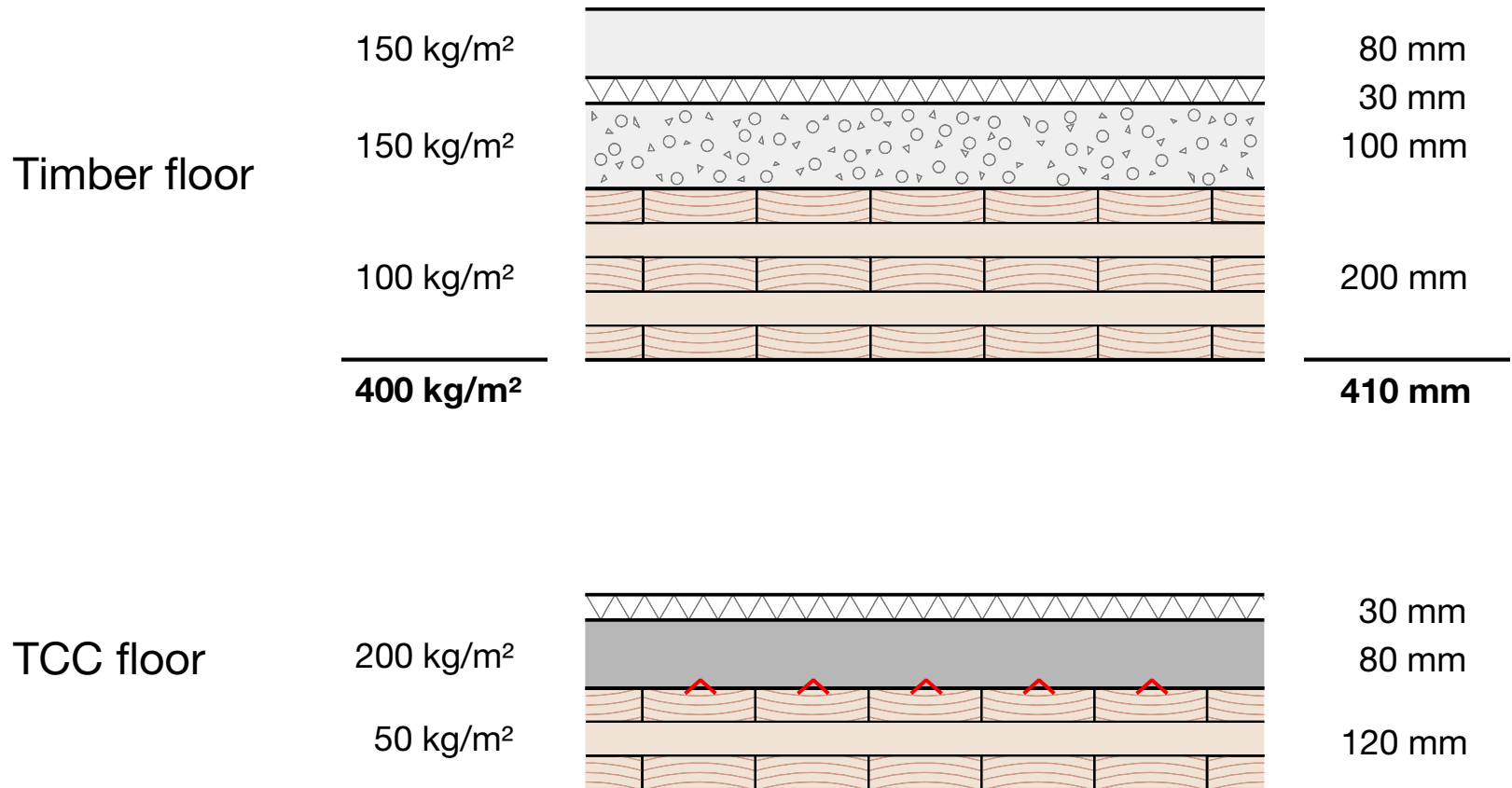

Residential floor system

About 5 m span length

$L'_{nT,W} \approx 43$ dB (Weighted Standardized Impact Sound Pressure Level)

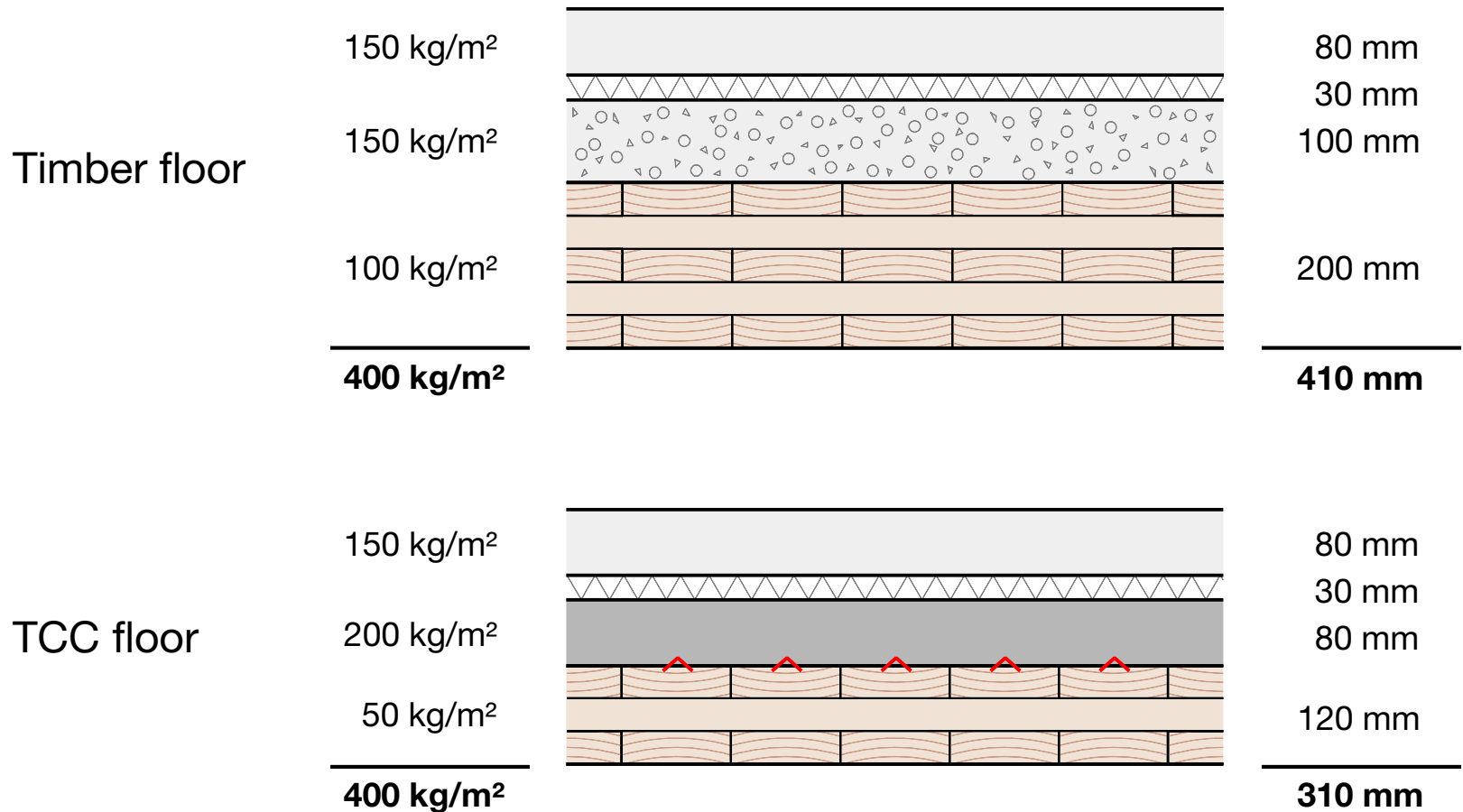



- When and Why?
- Composite action
- Classification
- Projects

Composite action

1 beam

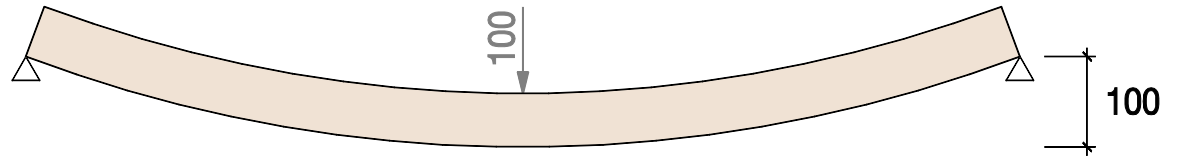

Composite action

1 beam

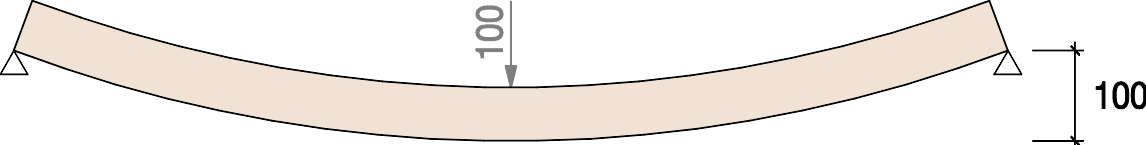

2 beams

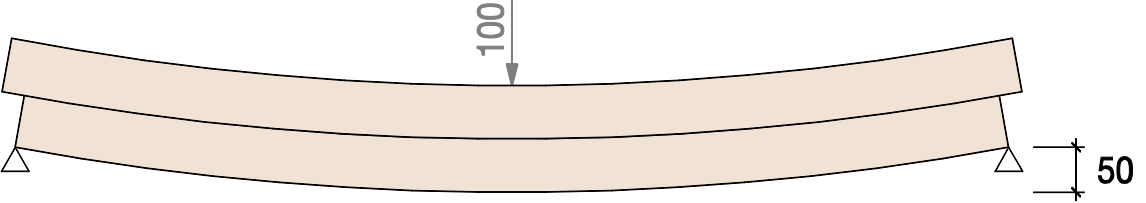

Composite action

1 beam

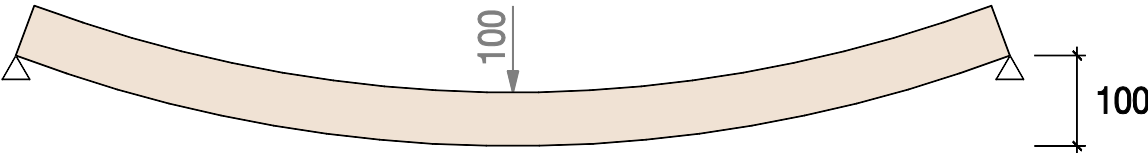

2 beams

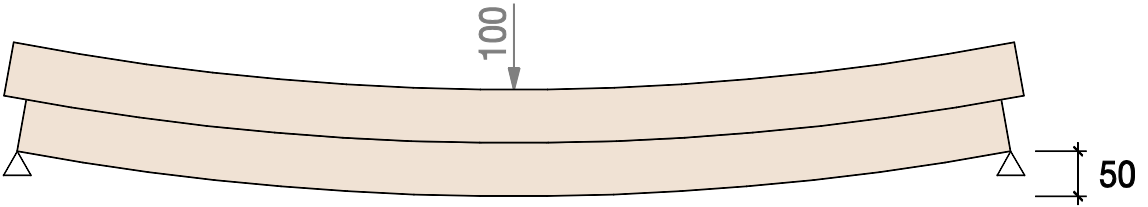

Glued connection

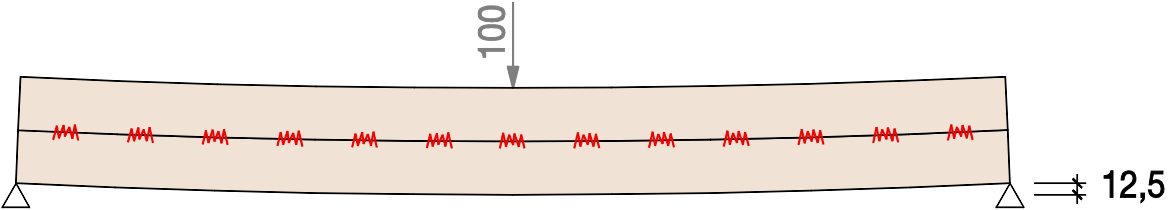

Composite action

1 beam

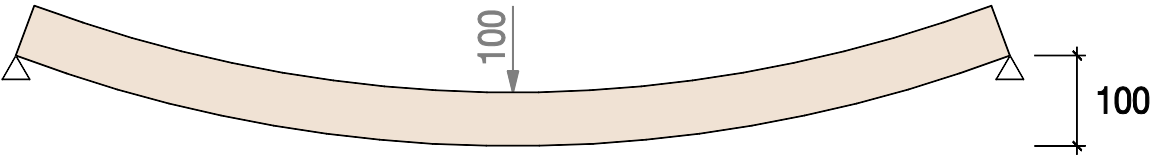

2 beams

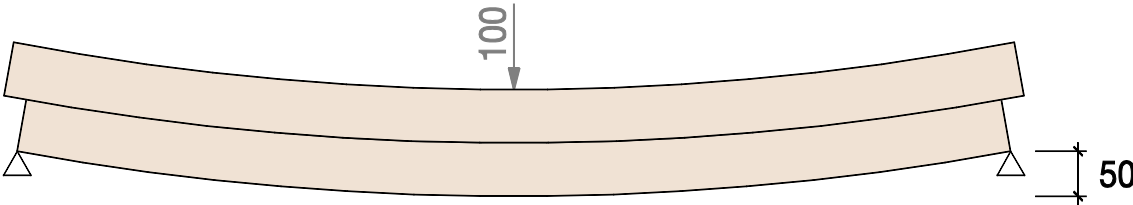

Glued connection

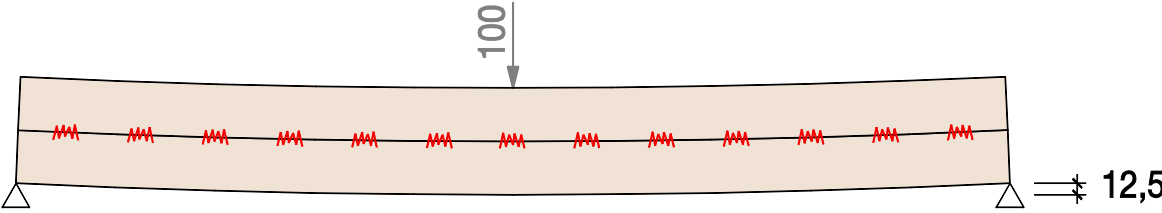

Composite action

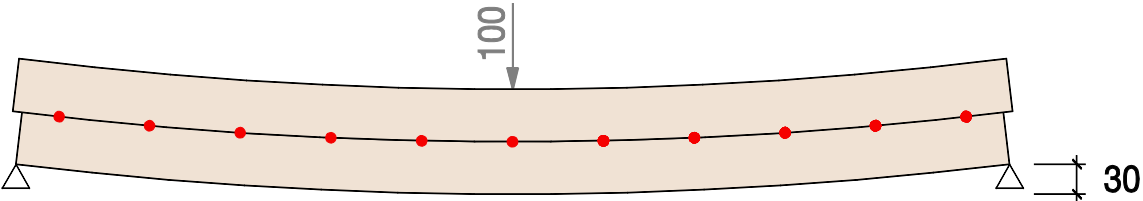



- When and Why?
- Composite action
- **Classification**
- Projects



- Classification
 - Cross-section
 - Type of connection
 - Process



Cross-sections

Nail laminated timber (NLT)

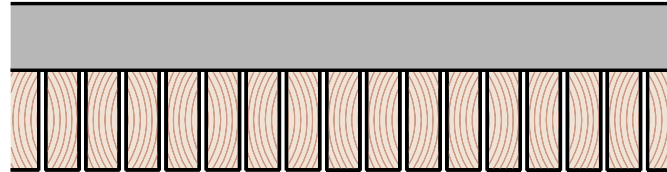

Cross-sections

Nail laminated timber (NLT)

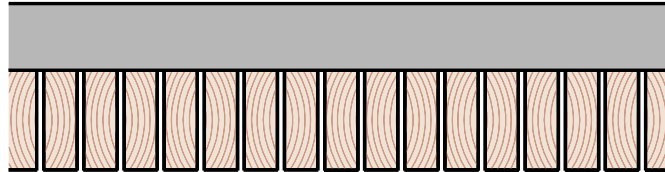

Cross-laminated timber (CLT)

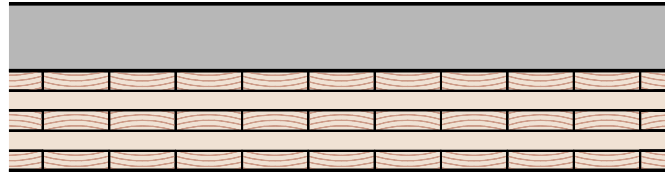

Cross-sections

Nail laminated timber (NLT)

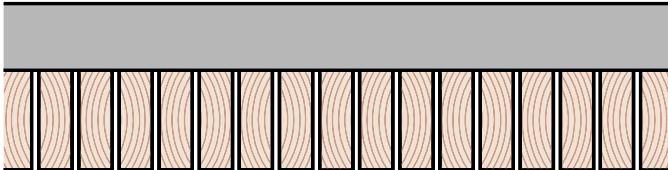

Cross-laminated timber (CLT)

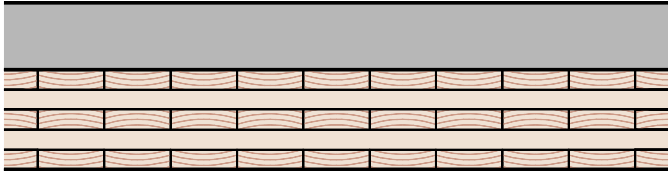

Tilted glulam beams

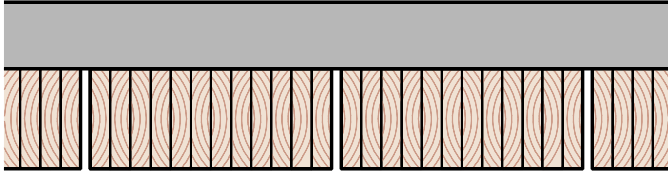

Cross-sections

Nail laminated timber (NLT)

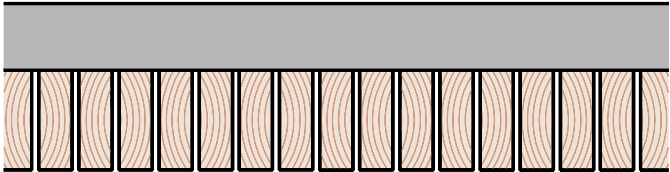

Cross-laminated timber (CLT)

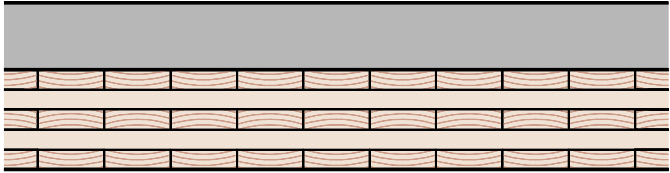

Tilted glulam beams

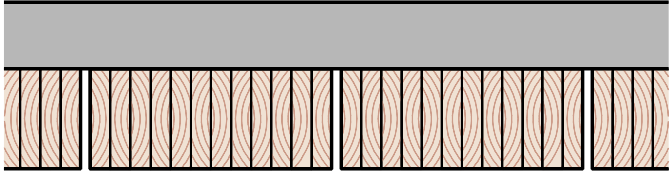

Joists

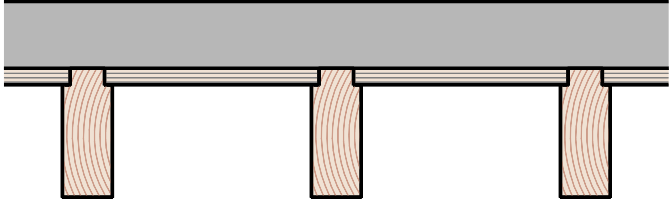



- Classification
 - Cross-section
 - Type of connection
 - Process

Types of joints

Grooved connections

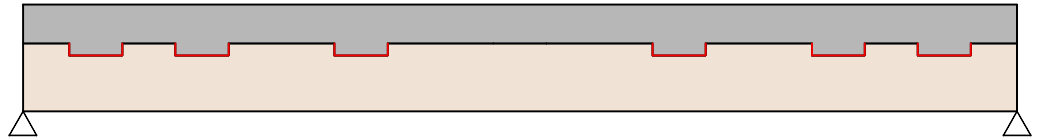



Types of joints

Grooved connections



Threaded steel fasteners

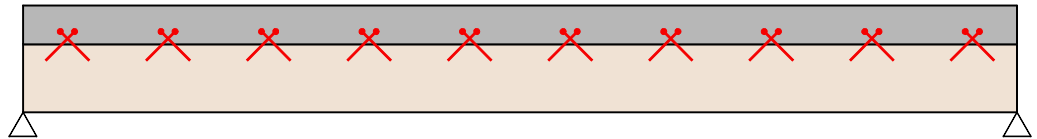



Types of joints

Grooved connections

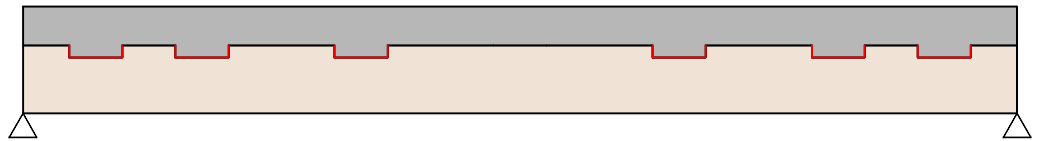

Threaded steel fasteners

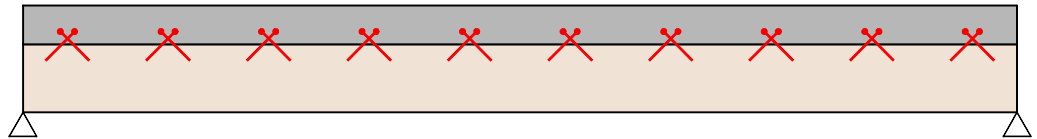

Glued-in steel connectors

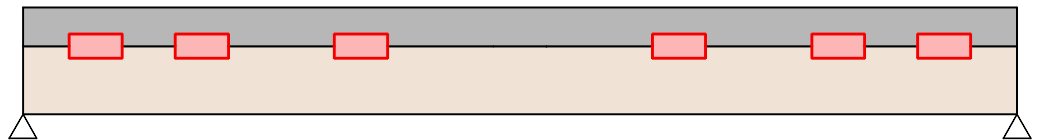



Types of joints

Grooved connections

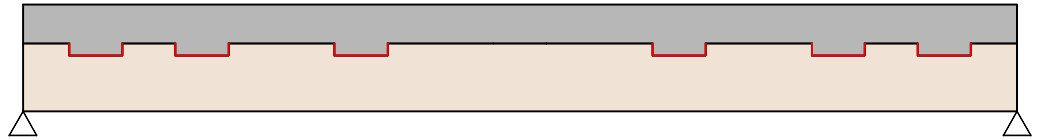

Threaded steel fasteners

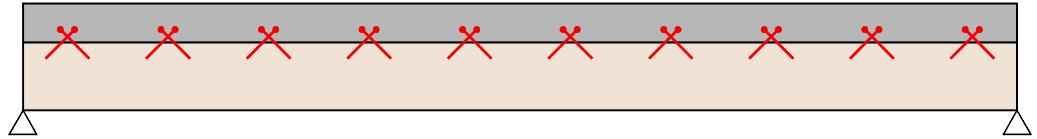

Glued-in steel connectors

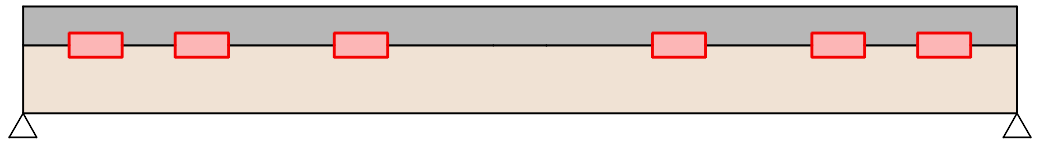

Epoxy adhesive

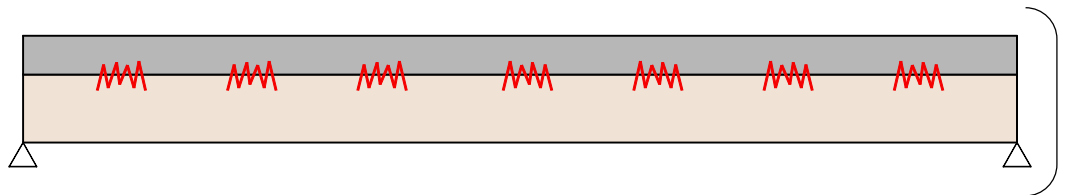





- Classification
 - Cross-section
 - Type of connection
 - Process

Wet method : concrete poured on site

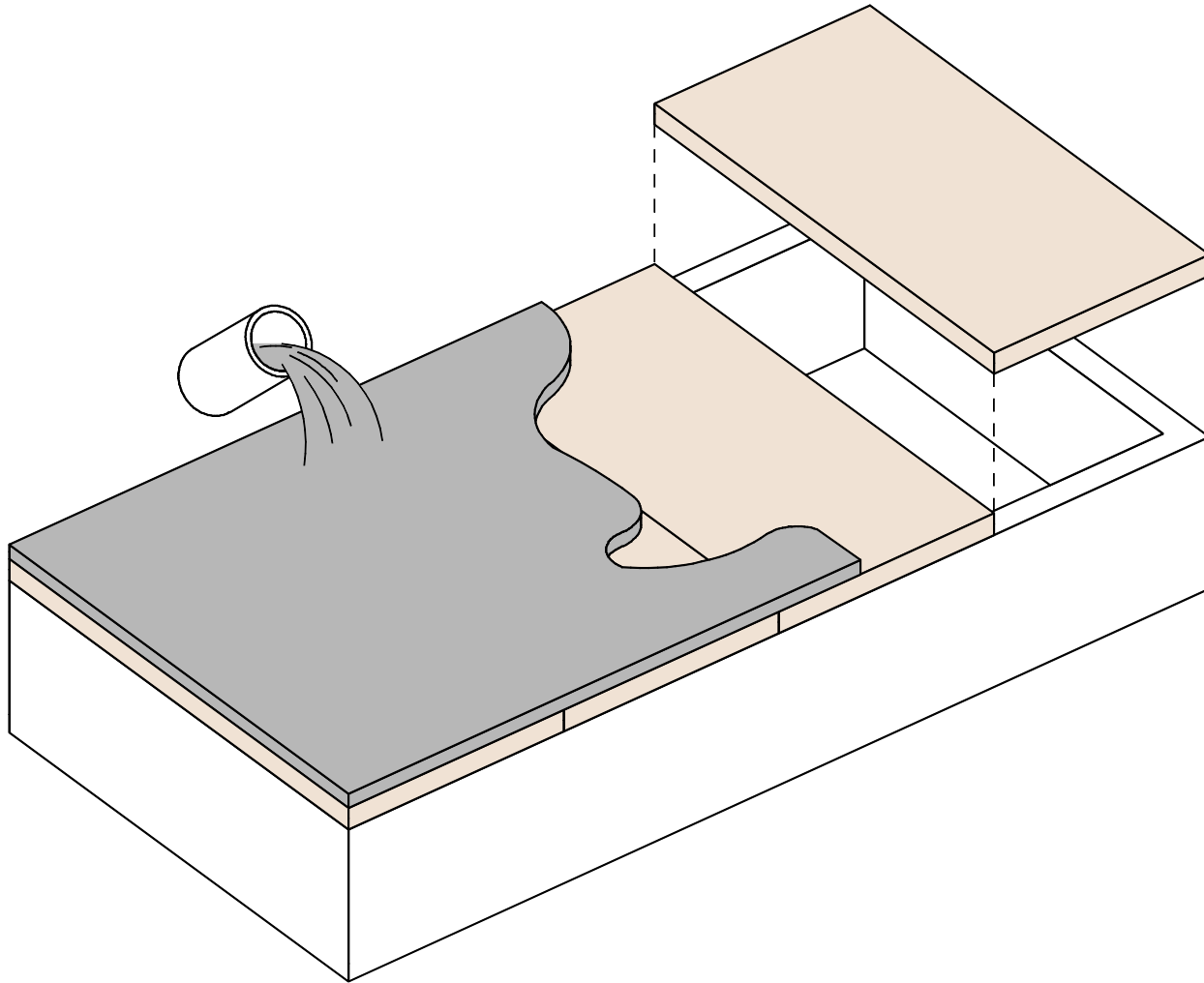





HBV-Plattenbalkendecke mit Ortbeton

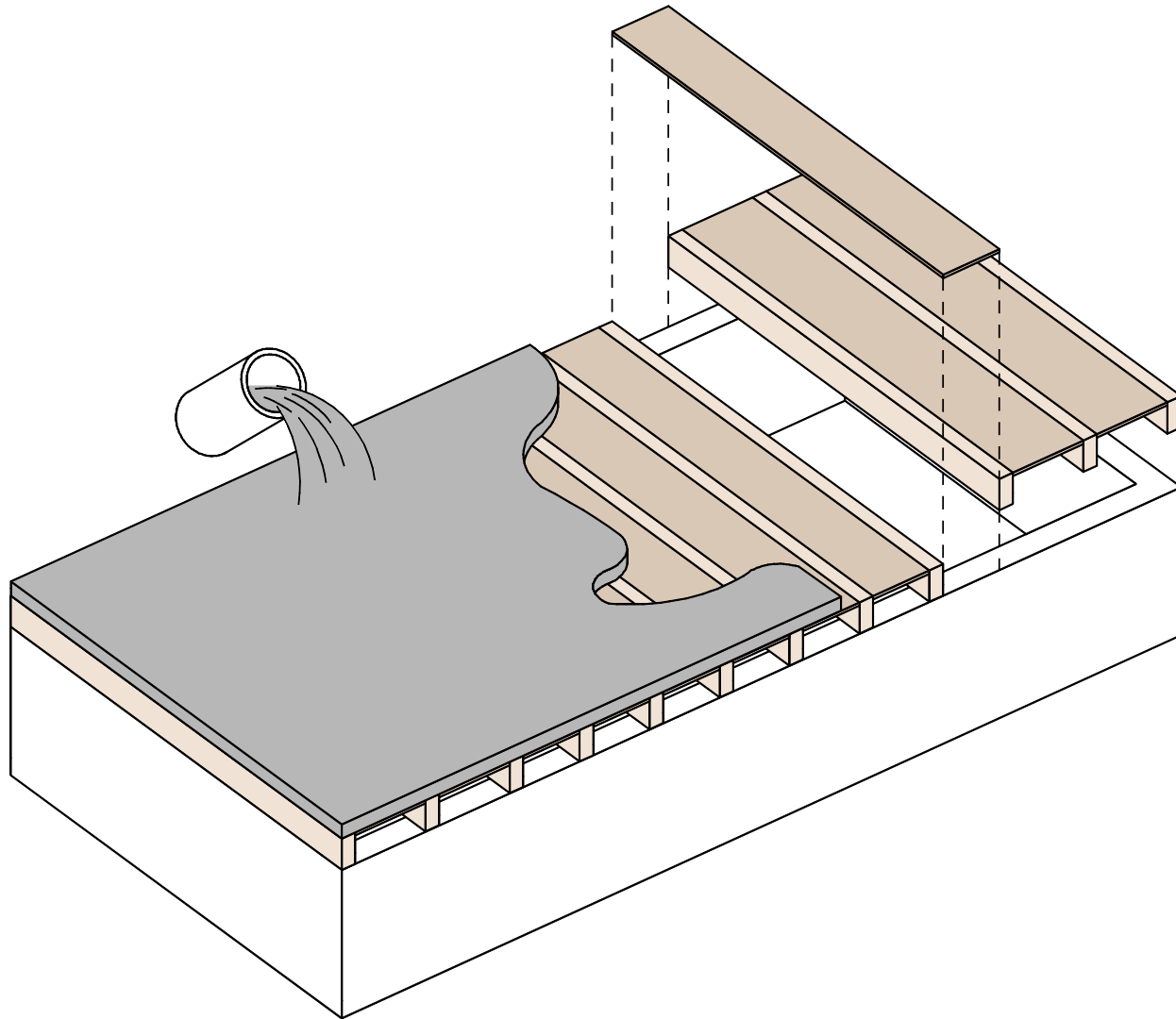



056

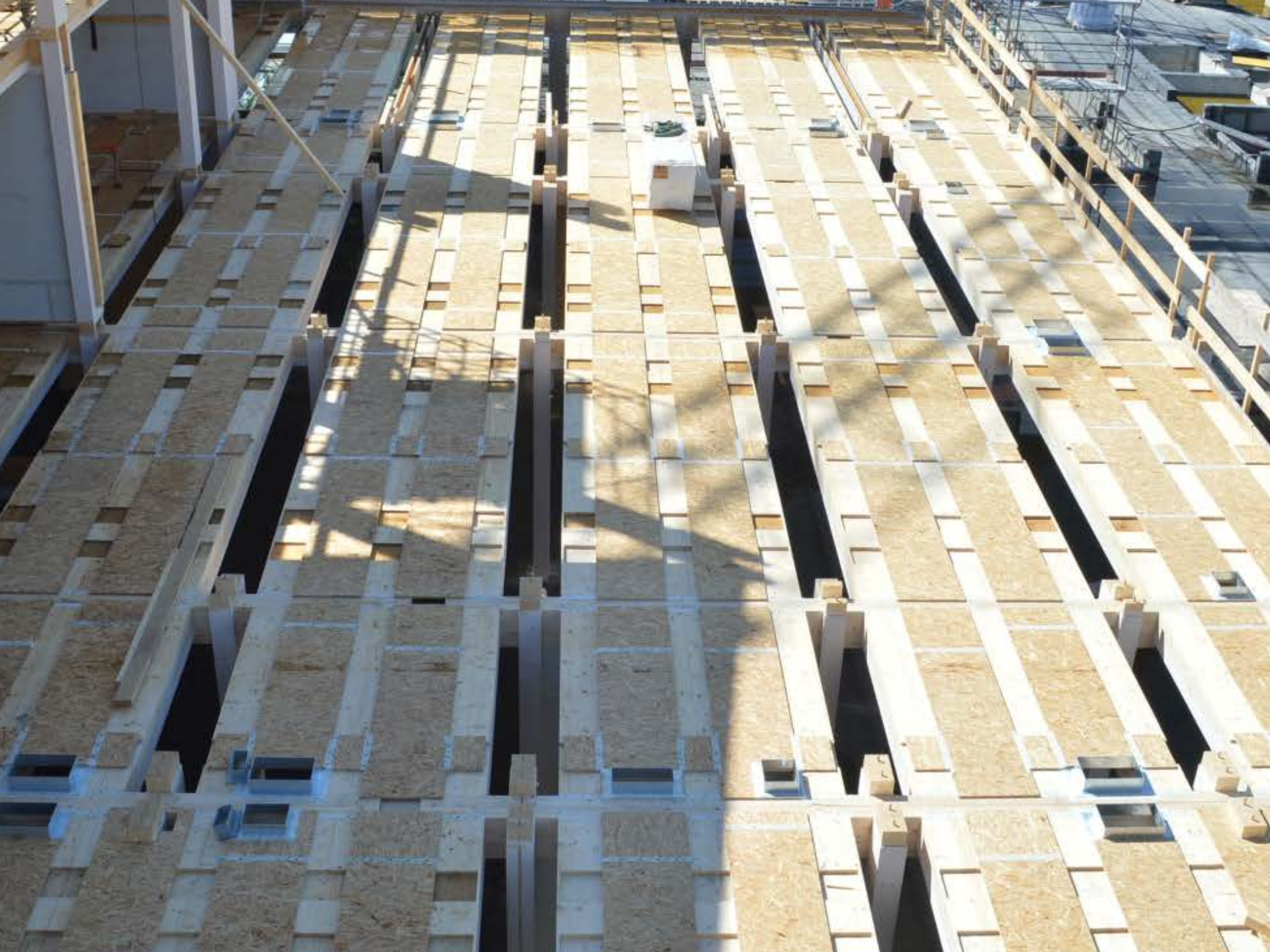











149g

ON
TARE

OFF

Max 2200g
0.1g

NET

0.250g

SOENNE

PROFESSIONAL

8241













Gymnasium Diedorf, D

Architekten: Florian Nagler / Hermann Kaufmann



Prefabrication method: TCC panels manufactured off site

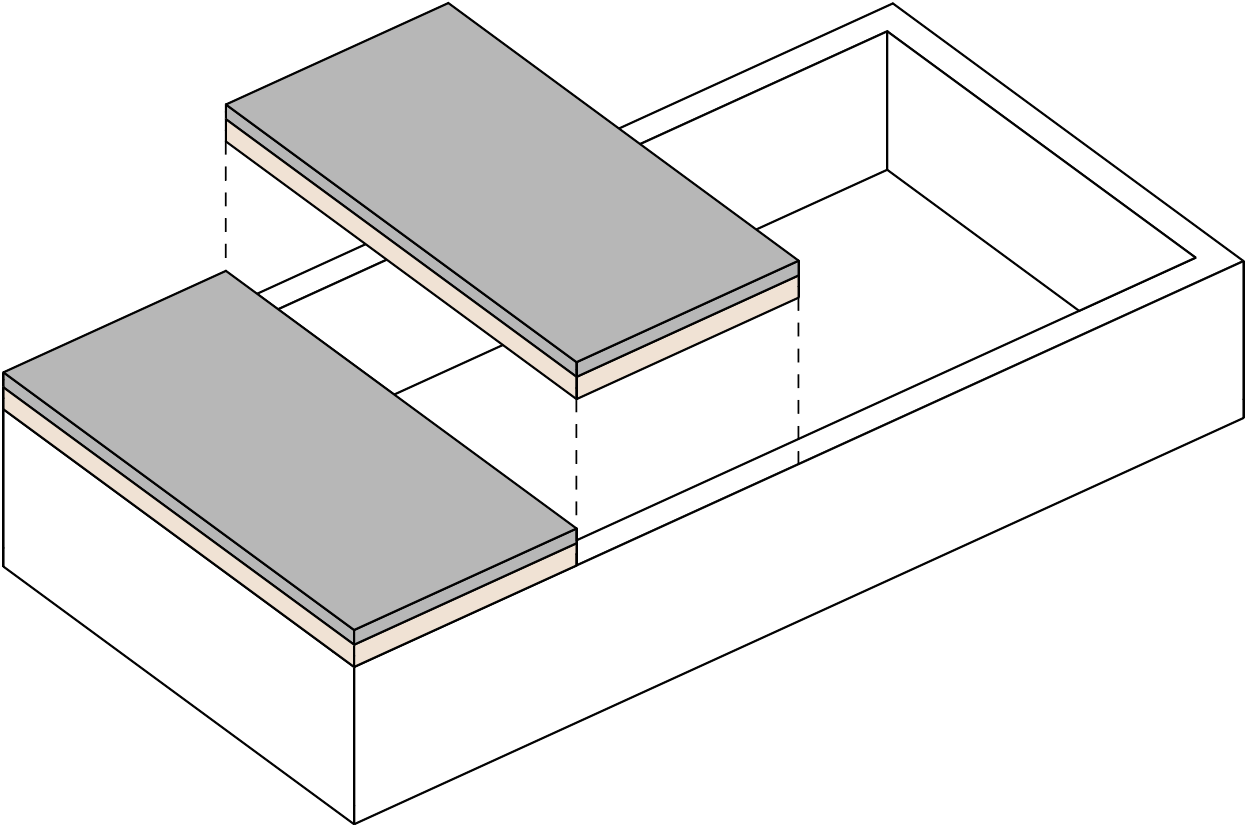









Im Werk vorgefertigte HBV-Plattenbalkendecken

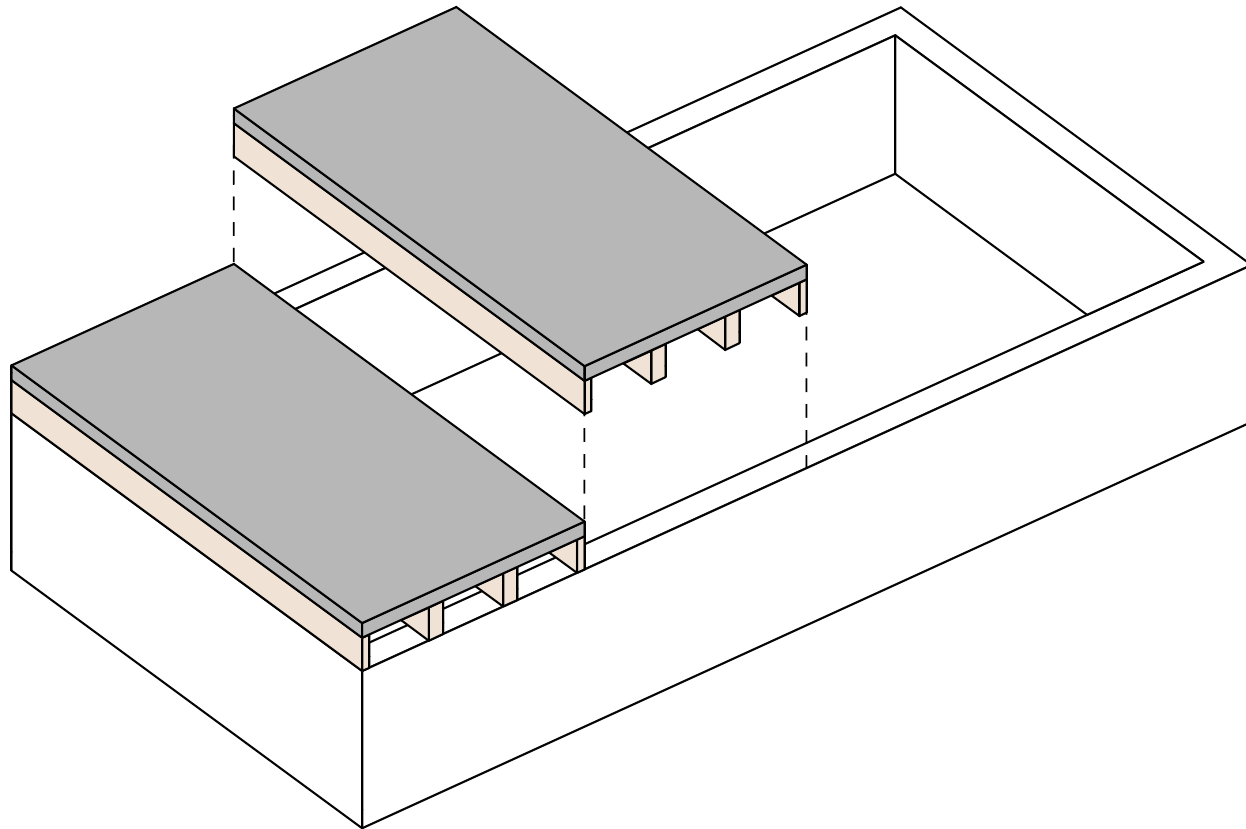













SONN





Semi-prefabrication method: concrete panel prefabricated off site

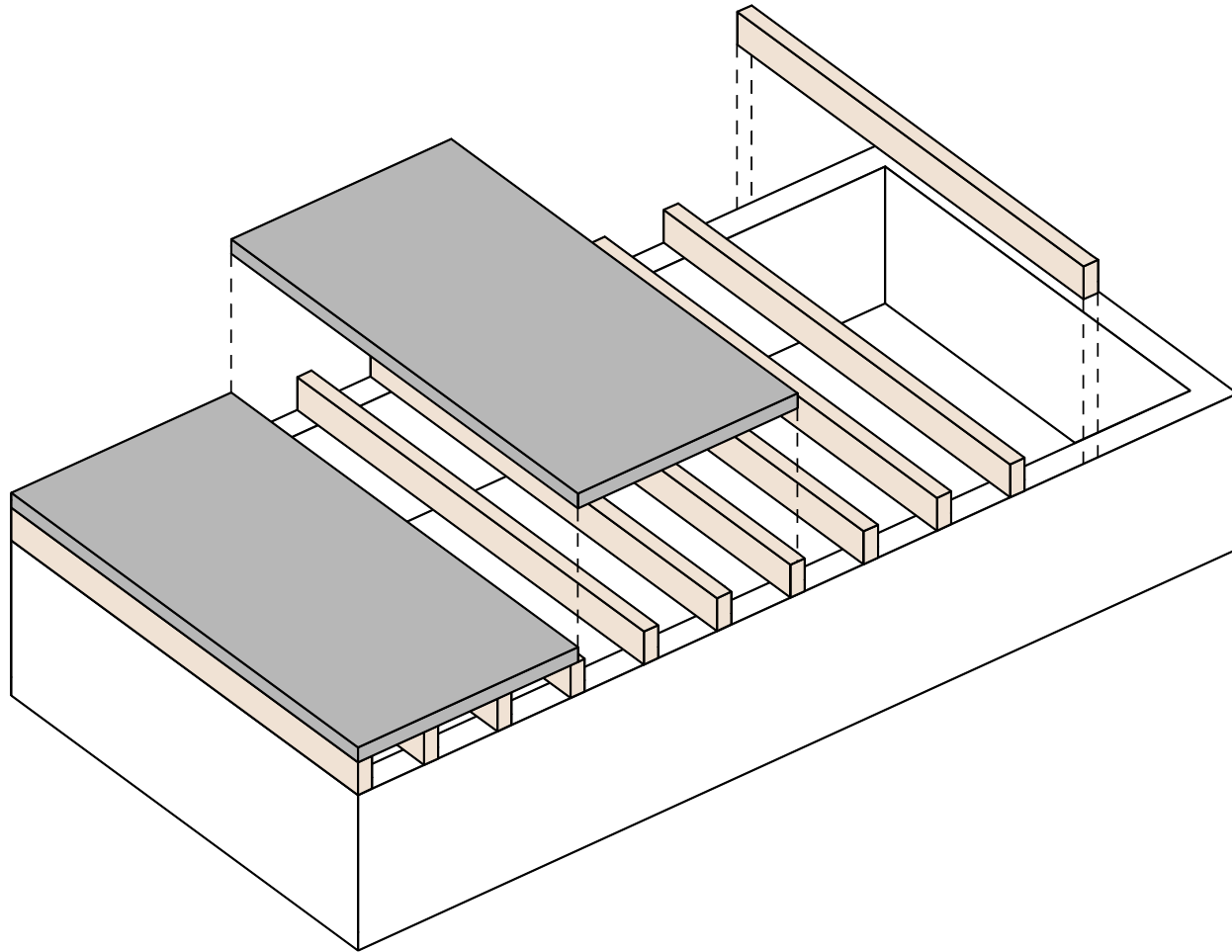







Würth System



Produktions- und Verwaltungsgebäude, Biel

Architekt: Burckardt Partner, Bern



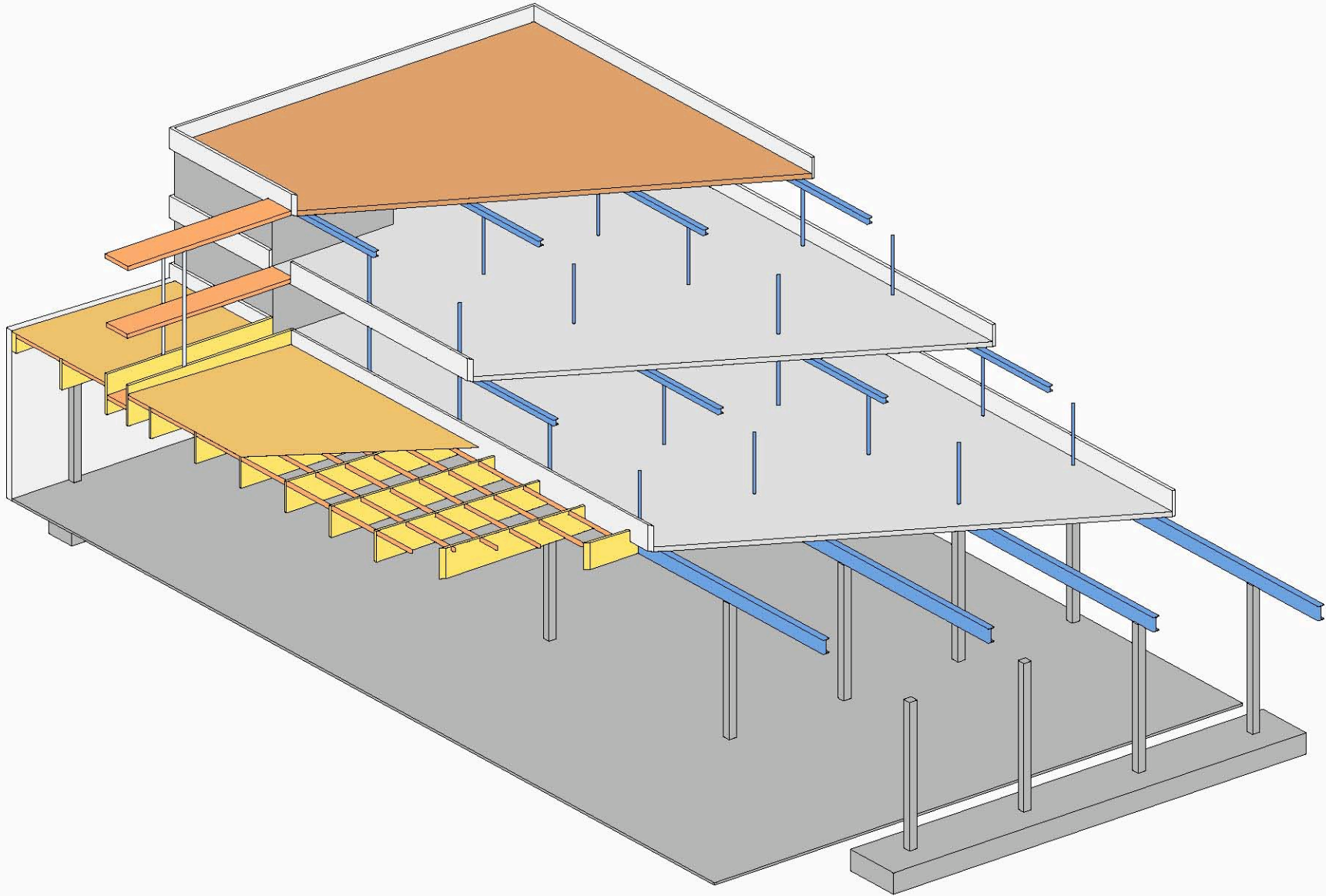

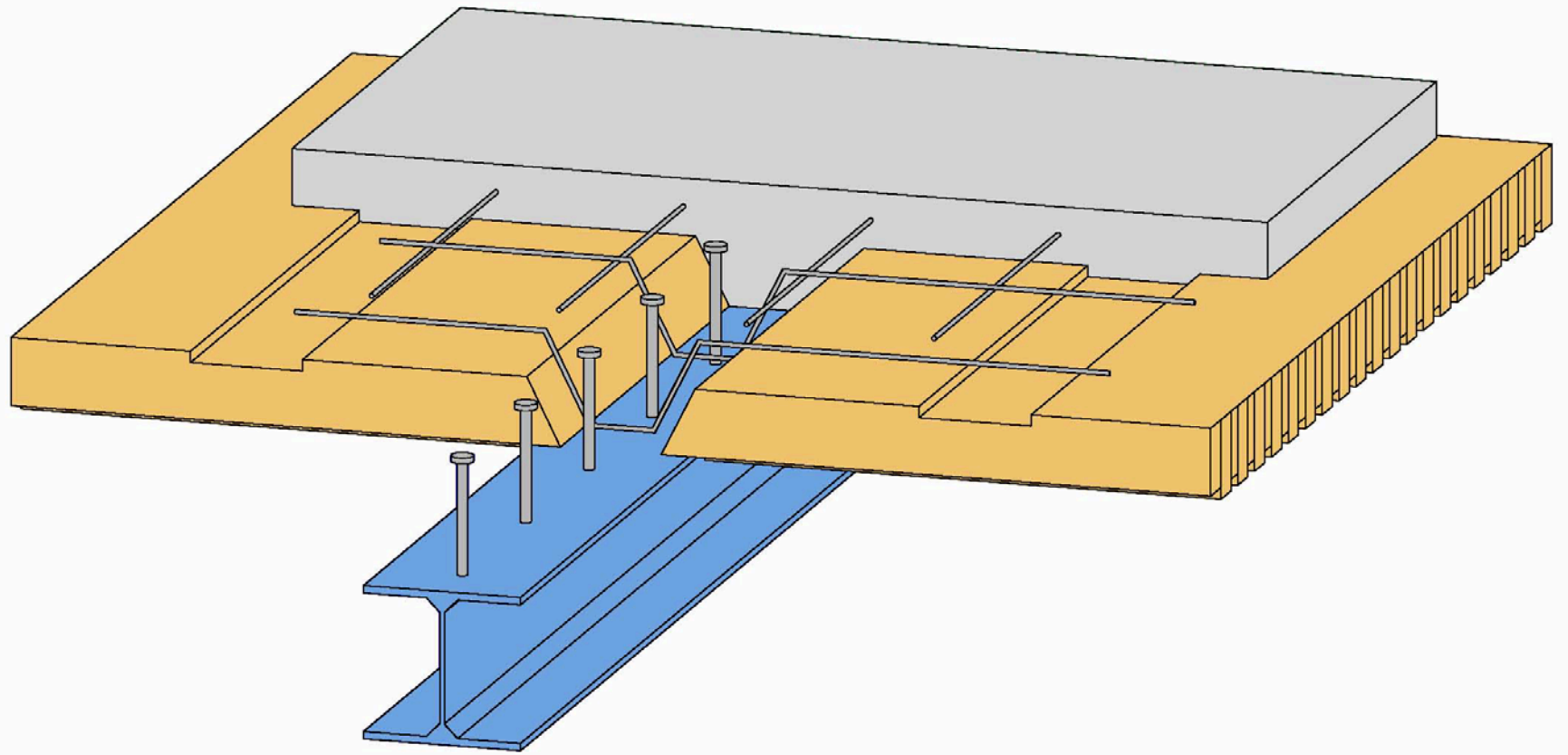

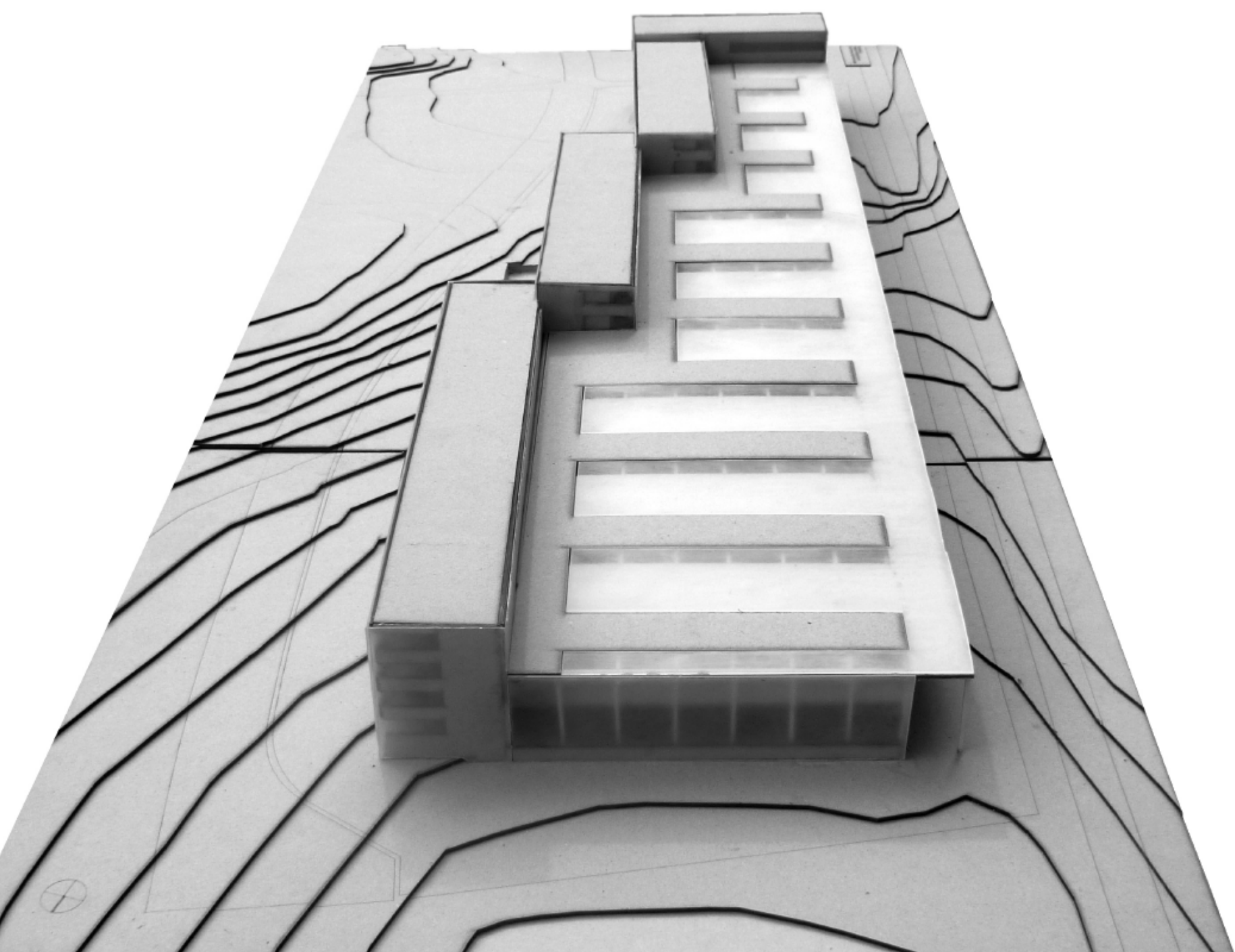

Grundriss M 1:1000

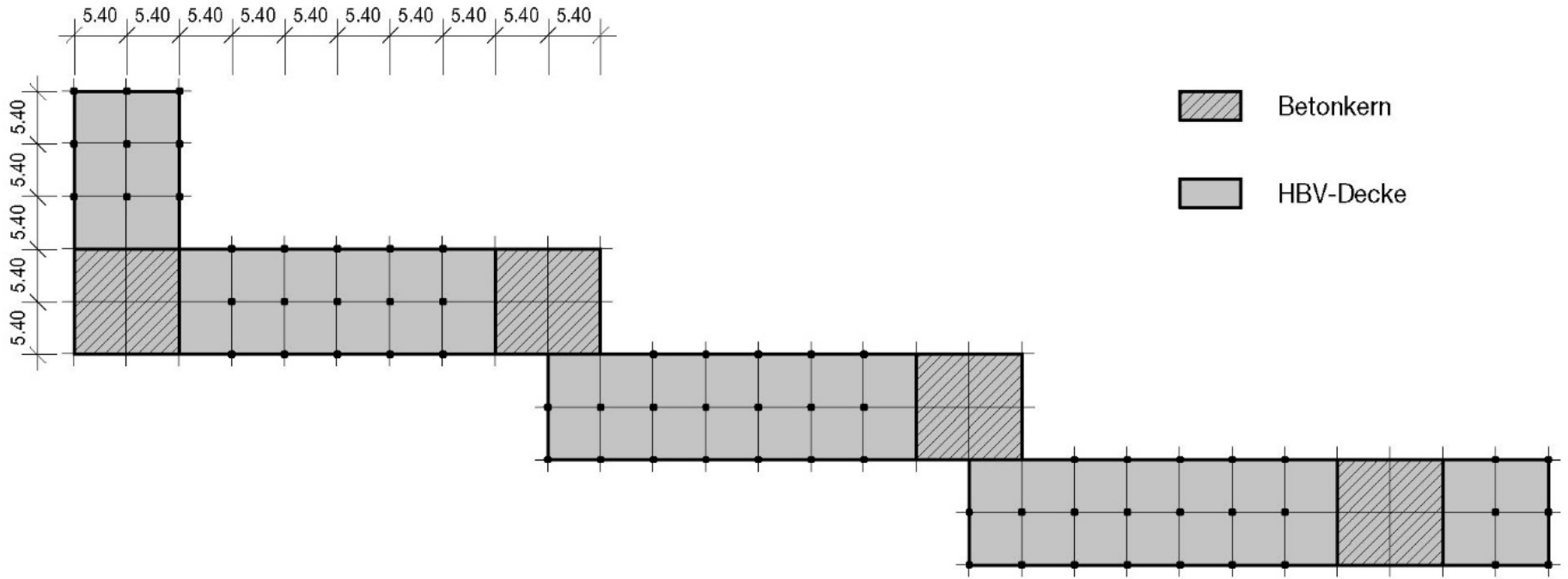

Wandelement Typ 1 Vertikalschnitt

M 1:10

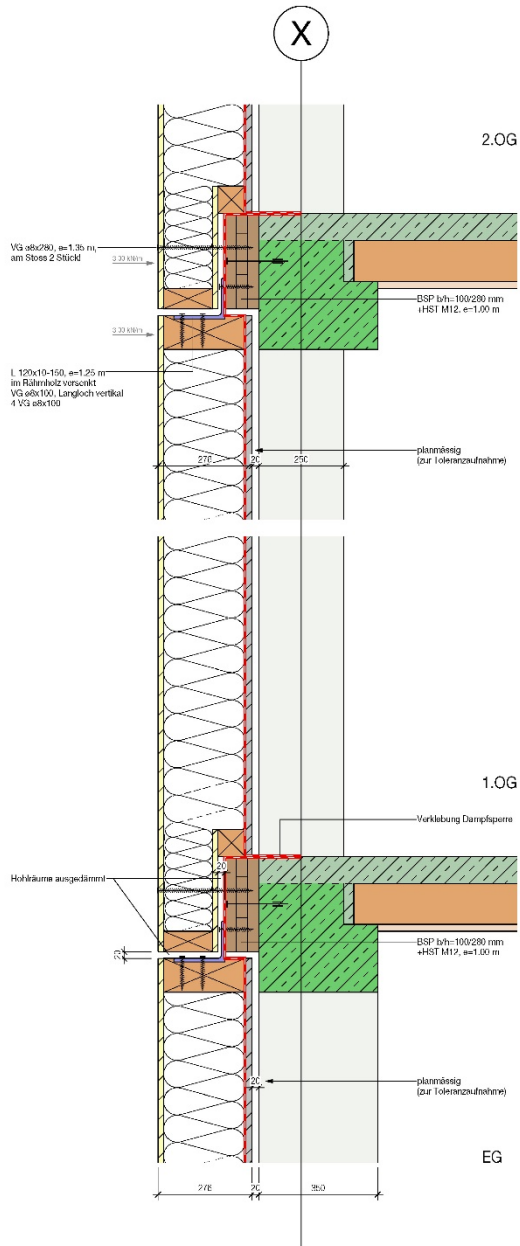

Wandelement Typ 2 Vertikalschnitt

M 1:10



Anschlüsse und Verbindungsmittel wie Typ 1

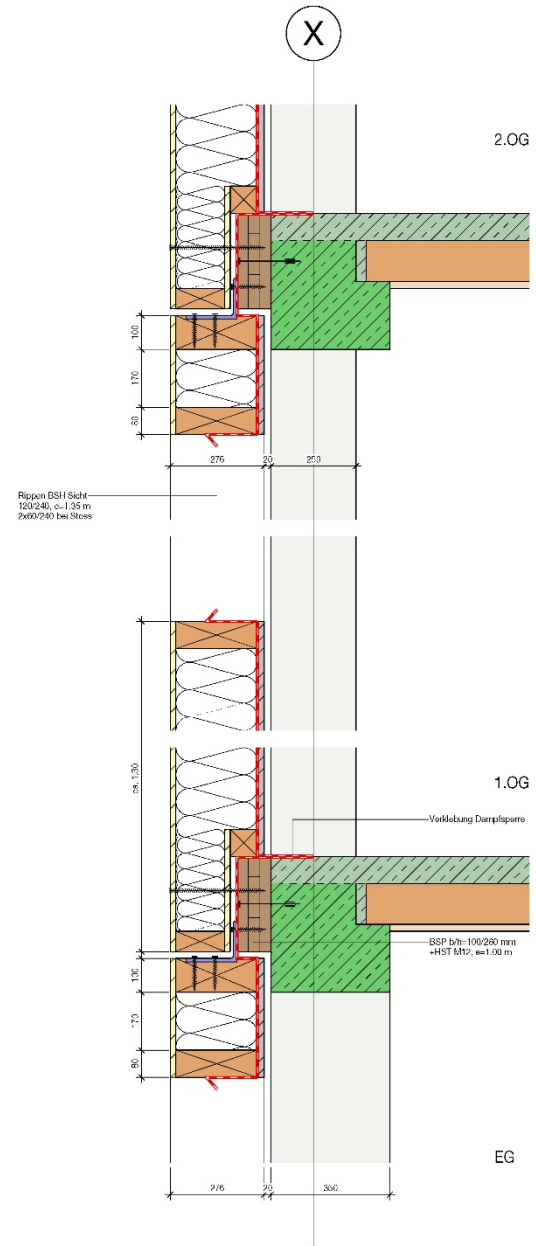

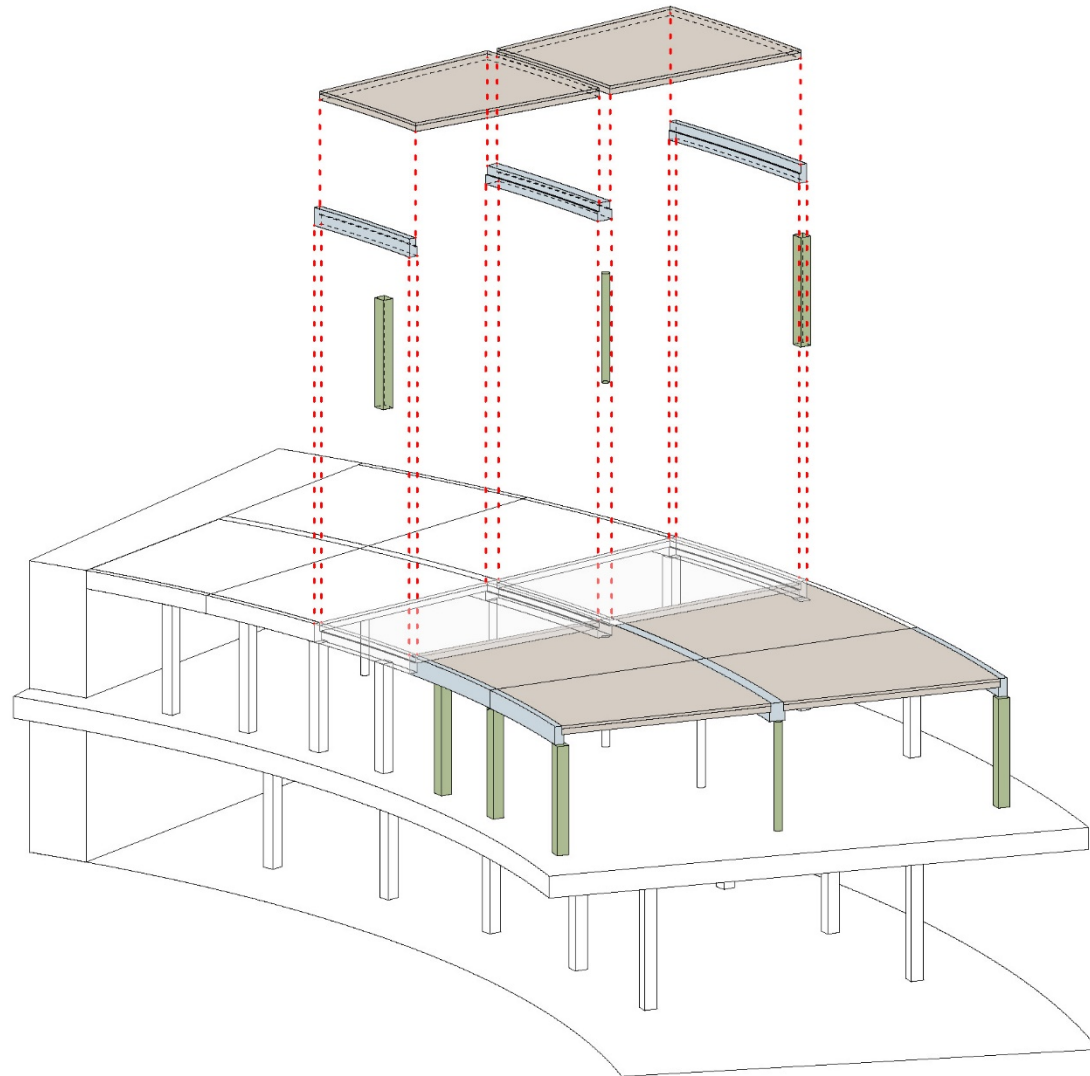

Modulares, vorgefertigtes Tragsystem

Detail Randträger

M 1:10

Warmdach 2. Bauetappe

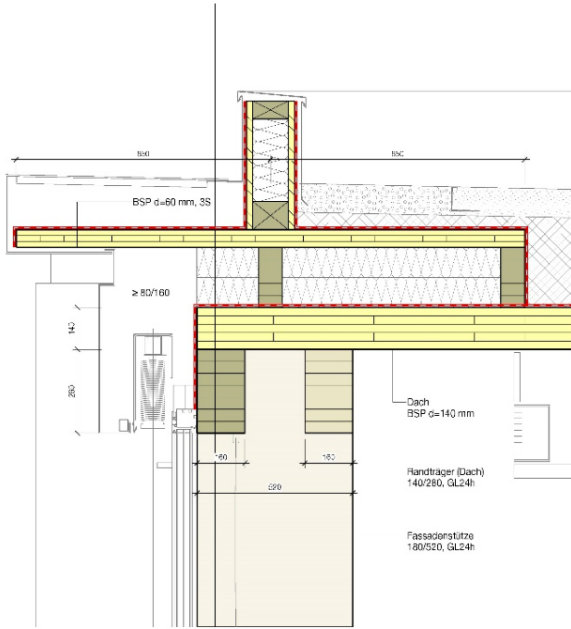

Detail Mittelträger

M 1:10

Warmdach 2. Bauetappe

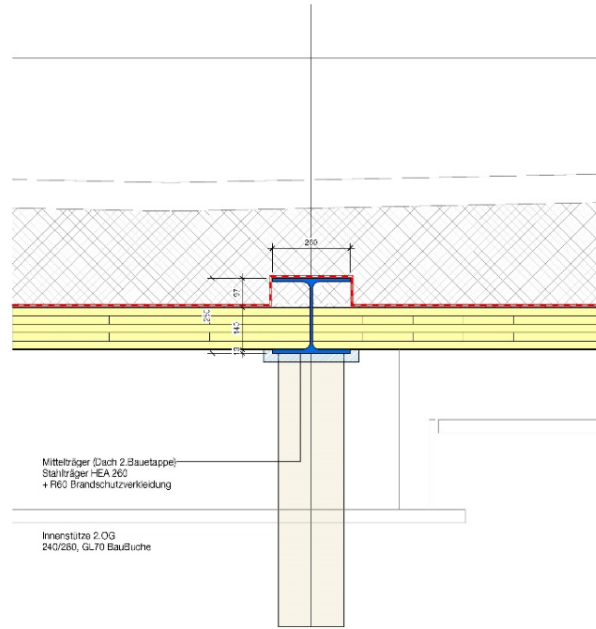

Decke 2. Bauetappe

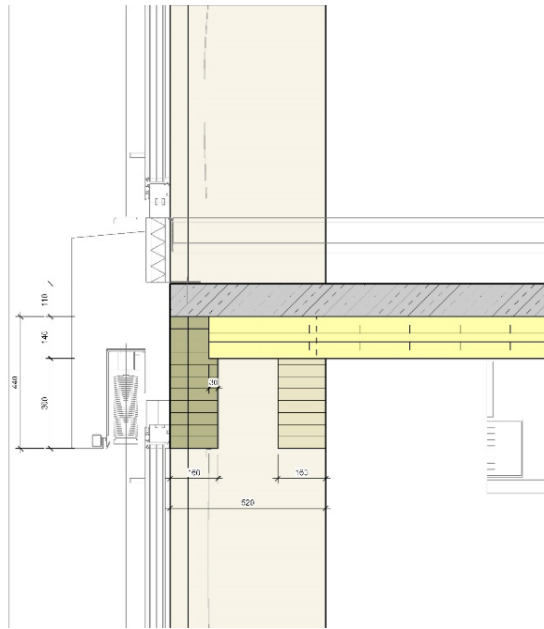

Decke 2. Bauetappe

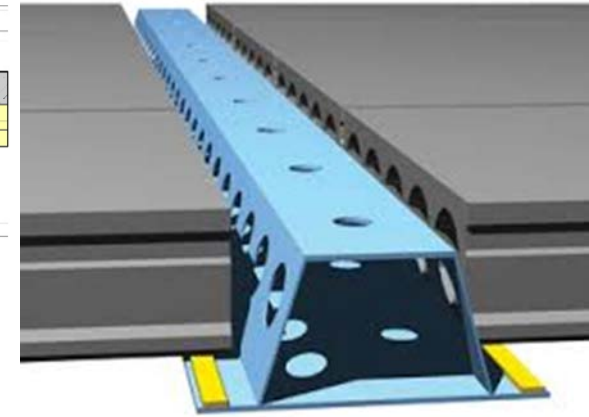
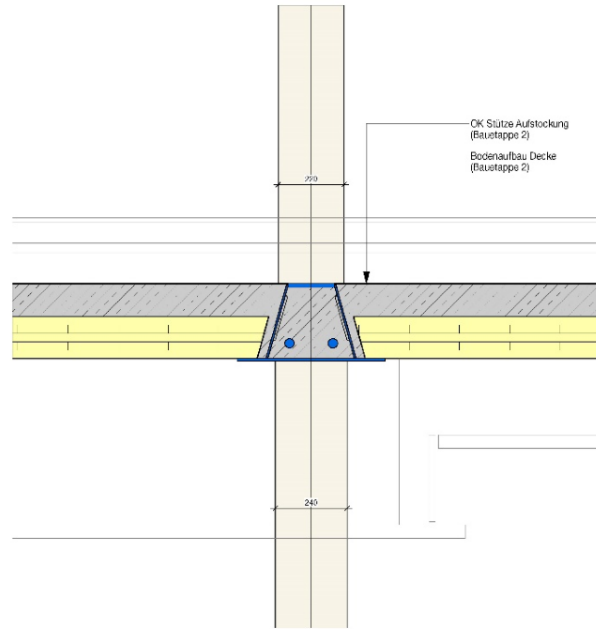

Deckenkonstruktion M 1:100

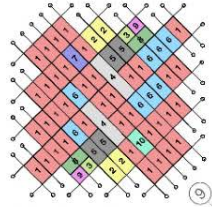

- 1 38x horizontal
- 2 4x horizontal
- 3 2x horizontal
- 4 2x horizontal
- 5 4x horizontal
- 6 6x horizontal
- 7 1x horizontal
- 8 2x horizontal
- 9 2x horizontal
- 10 1x horizontal

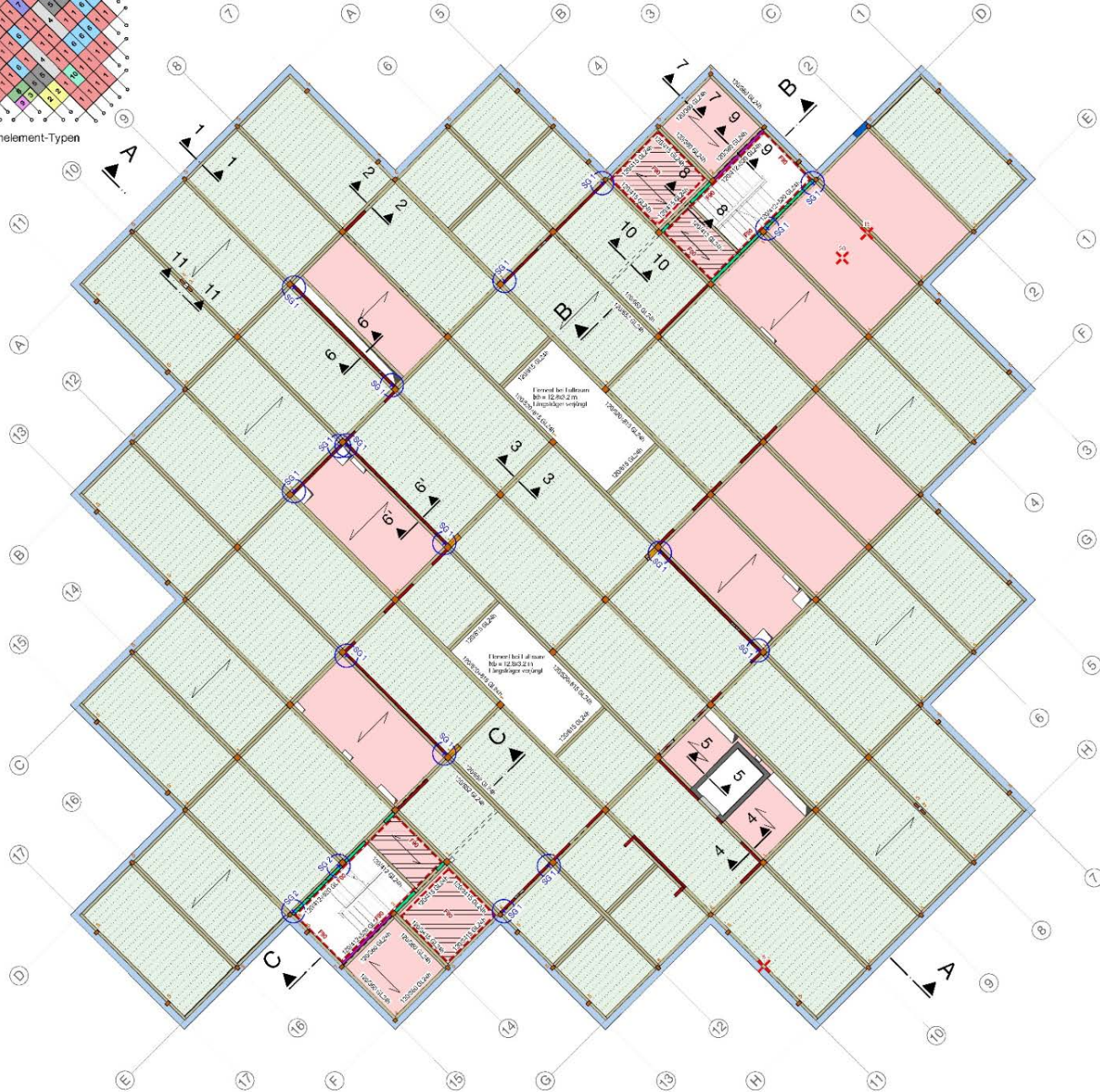

Decke

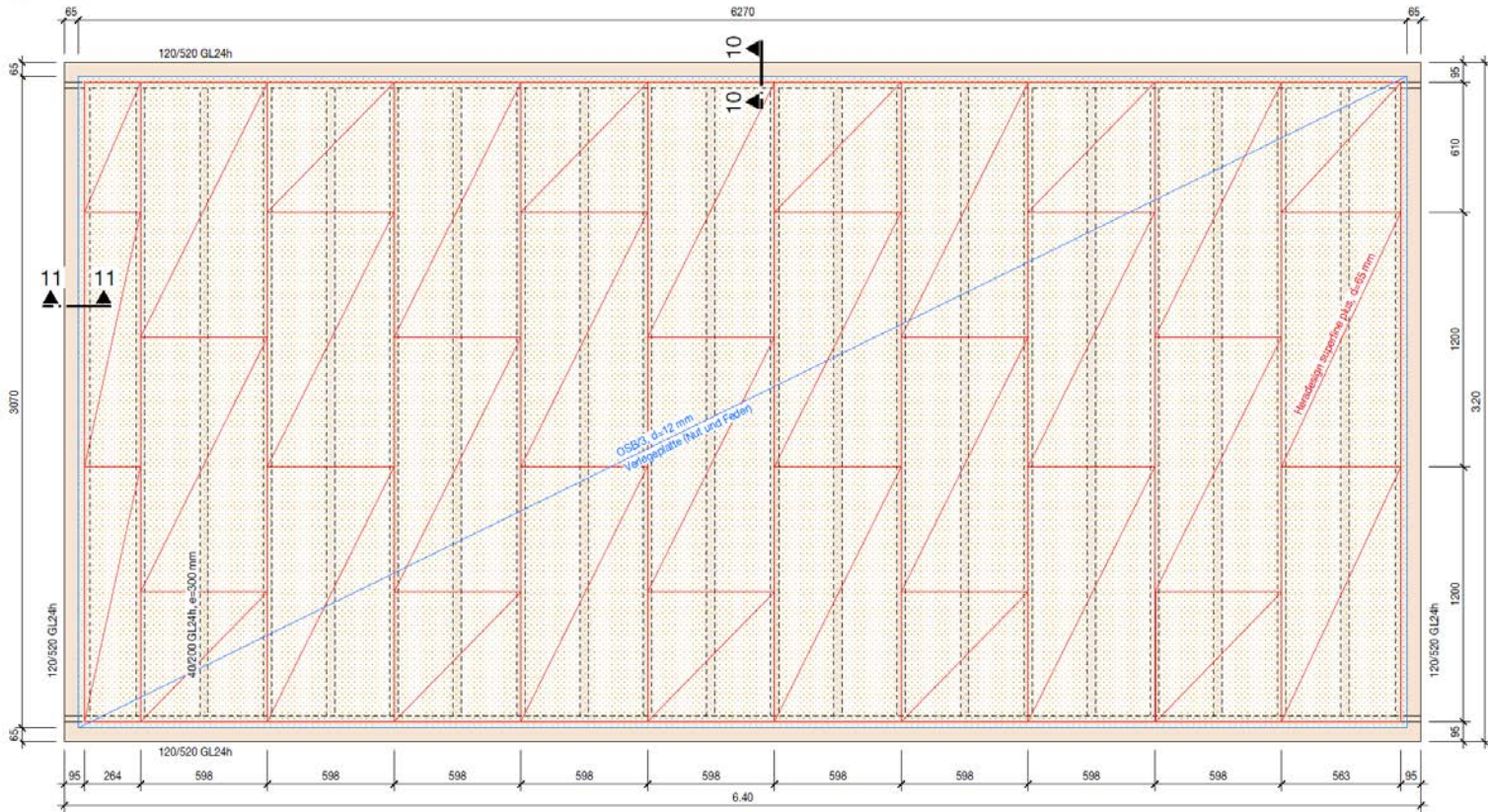

Schnitt 10-10 M 1:10

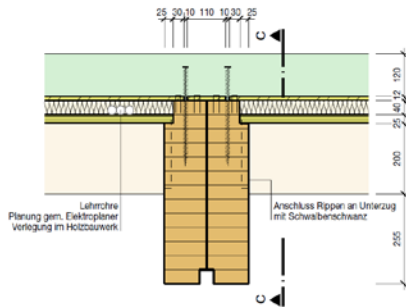

Schnitt 11-11 M 1:10

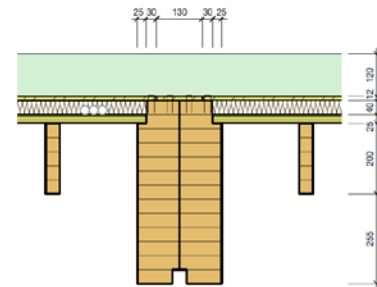
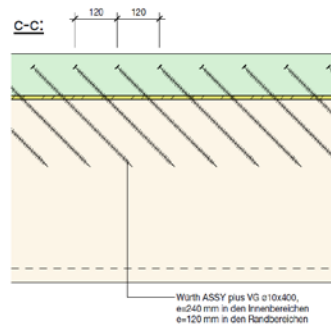









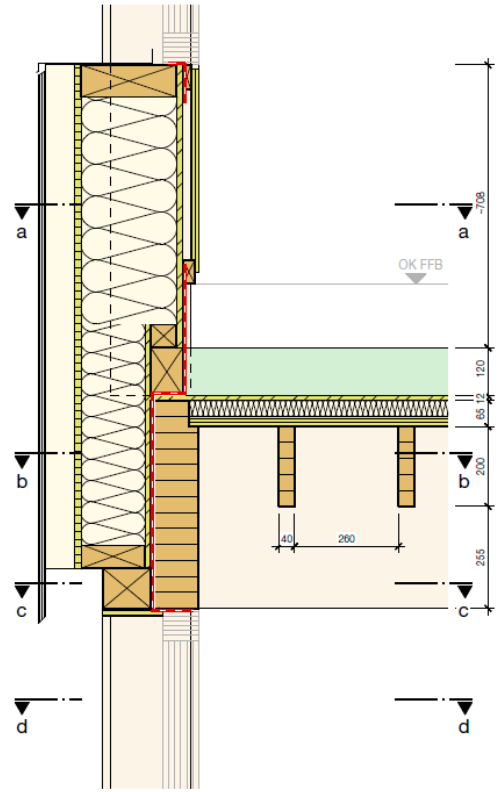
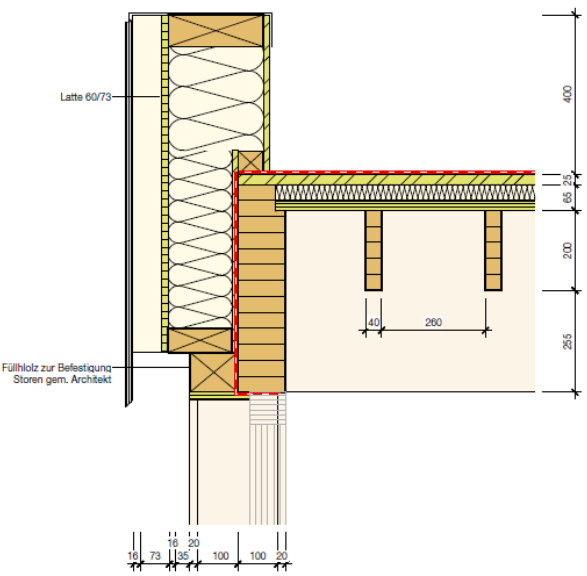

www.mkp-ing.com